



GreenPoint RATED

**Labeling and Design Guidelines for Hot Water Efficiency
ACEEE 2008 Forum on Water Heating and Use
Sacramento, CA June 1-3, 2008**

**Jennifer Love
Program Manager, Build It Green
510.845.0472 ext 102
jen@builditgreen.org**



GreenPoint Rated Overview



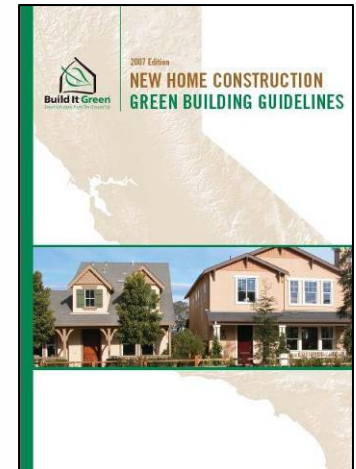

- Practices ABOVE code in California
- Based on the Green Building Guidelines
- New Single Family & Multifamily
- Launching July 2008: Existing Homes
- Program of Build It Green
 - ◆ Non-profit membership organization
 - ◆ Advocate for green building
 - ◆ Education, outreach & networking





Minimum Requirements

- Perform 15% above Title 24
- 50% Waste Diversion by Weight (Recycling or Reuse)
- GreenPoint Rated Checklist in Blueprints
- 3-Year Contractor Warranty for Shingle Roofs on Multifamily Projects

Category	Single-family		Multifamily	
	Min. Pts	Total Pts.	Min. Pts	Total Pts.
 Community	0	32	6	60
 Energy	30	193	30	70
 IAQ/Health	5	51	5	25
 Resources	6	103	6	64
 Water	9	71	3	36
Total	50	450	50	255







Hot Water Measures

					total
Showerheads < 2.0 gpm		1			1
Bathroom Faucets < 1.5 gpm		1			1
Kitchen & Utility Faucets < 2.0 gpm		1			1
Clothes Washer meets CEE Tier 2	1	2			3
Clothes Washer meets CEE Tier 3		2			2
Energy Star Dishwasher	1				1
Dishwasher Uses < 6.5 gal/cycle		1			1
Zoned, Hydronic Radiant Heating	1		1		2

Using Hot Water



Hot Water Measures

						total
Making	Solar Water Heating System	10				10
	15% above Title 24 - Required	30+				30+
	Sealed Combustion Water Heaters			2		2
	Drain Water Heat-recovery System	1				1
Getting	Insulate Hot Water Pipes to Kitchen	1	1			2
	Insulate All Hot Water Pipes	1	1			2
	Engineered Parallel Piping		1			1
	Engineered Parallel Piping w/ Demand Recirc		1			1
	Structured Plumbing w/ Demand Recirc	1	2			3
	Central Core Plumbing	1	1		1	3



Engineered Parallel Piping

■ Standard

- ◆ Trunk line < 5 ft from water heater
- ◆ Pipe volume < 4 cups per line

■ With Demand Controlled Circulation Loop

- ◆ on demand recirc
- ◆ < 3 cups
- ◆ < 1/2 cup in manifold

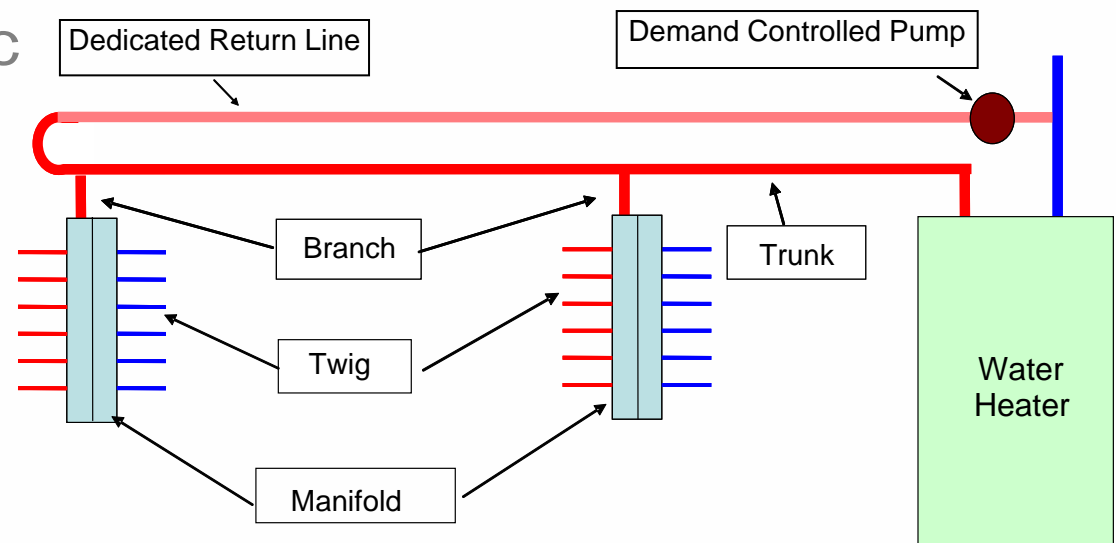



Structured Plumbing

- Trunk line: $\frac{3}{4}$ " pipe
- Twigs: $< \frac{1}{2}$ " pipe , < 2 cups, < 10 ft
- On demand recirculation pump

- ◆ No timer
- ◆ Button or sensor
- ◆ Dedicated return or cold water line

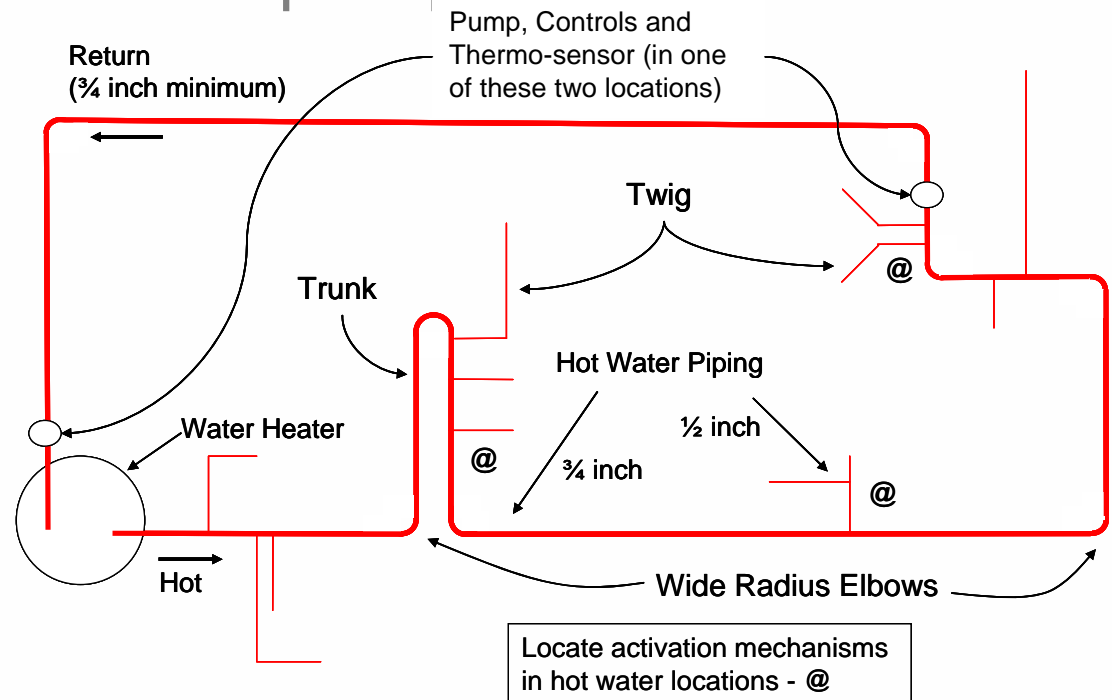

Structured Plumbing

- Trunk line: 3/4" pipe
- Twigs: < 1/2" pipe , < 2 cups, < 10 ft
- On demand recirculation pump
 - ◆ No timer
 - ◆ Button or sensor
 - ◆ Dedicated return or cold water line

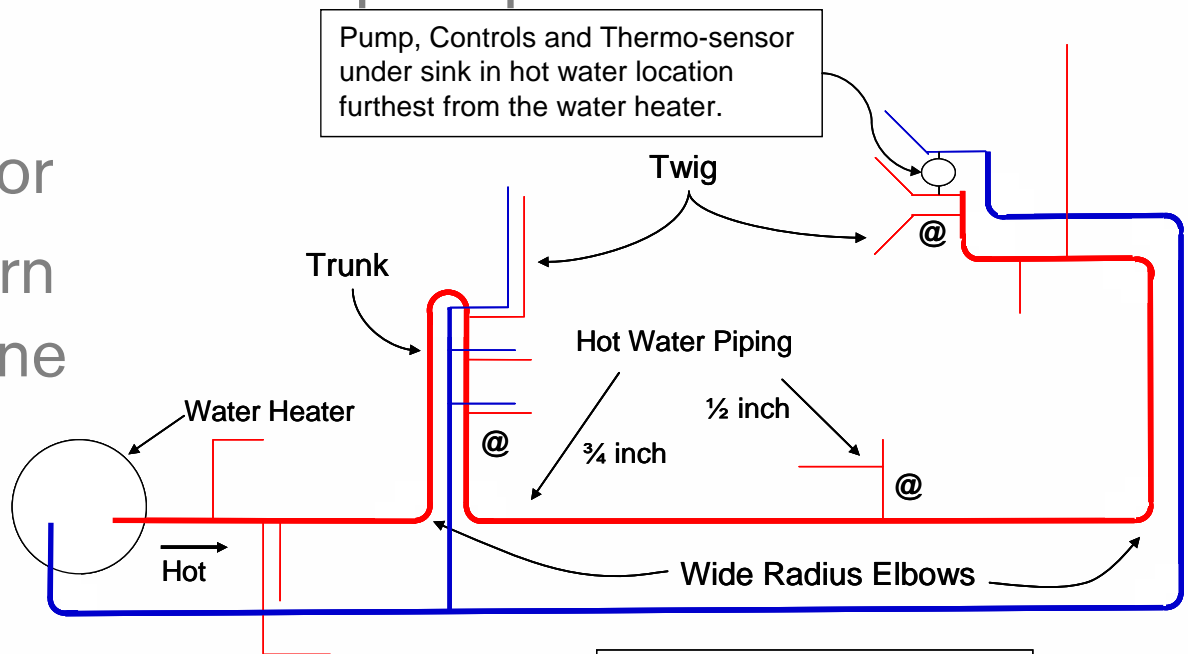



Central Core Plumbing

- Each line < 3 cups
- Minimize 90° elbows
- R4 insulation
- Less material

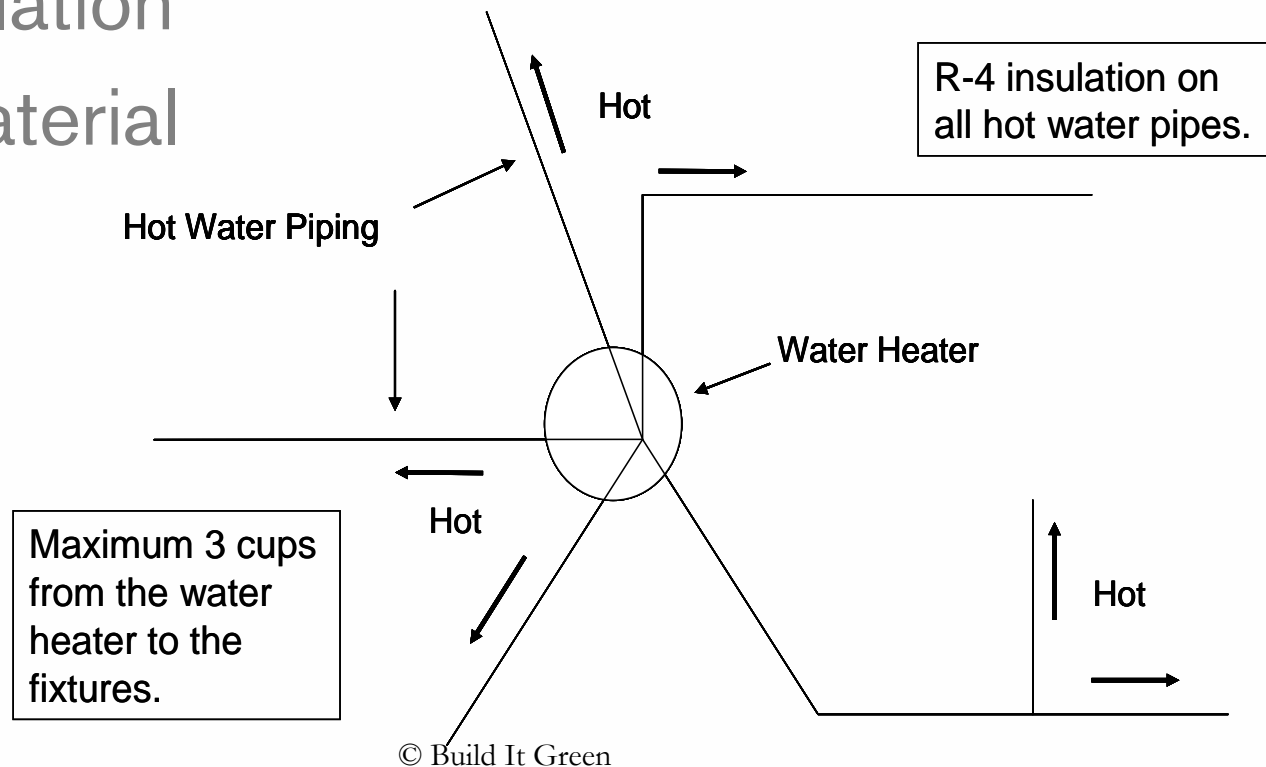



Thanks to our Sponsors!

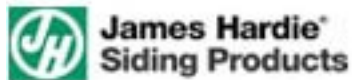



Questions...



Jennifer Love, Program Manager
510-845-0472 x102
Jen@BuildItGreen.org

GreenPoint Rated Program
510-845-0472 x 8
GreenPointRated@BuildItGreen.org

www.GreenPointRated.org

