

Responsive and Intelligent Building Information and Control for Low-Energy and Optimized Grid Integration

*Mary Ann Piette, Jessica Granderson, Michael Wetter and Sila Kiliccote,
Lawrence Berkeley National Laboratory*

ABSTRACT

Buildings consume about 40 percent of total national energy use, are responsible for the same percentage of greenhouse gas emissions, and account for about 70 percent of electricity use. To address energy security issues and environmental concerns there is an urgent need to develop techniques that greatly reduce energy use and peak electric power in buildings while providing or improving the services provided. One of the greatest opportunities to address this need is to accelerate the development and deployment of advanced building energy information and control systems that improve energy efficiency. Similarly, information and control systems need to be responsive to demands and dynamic prices from the electricity grid by modifying electric loads during operations, while meeting needs of building occupants. This paper reviews progress in each of these areas and suggests how future integrated control systems should be designed and operated to ensure buildings are both efficient and demand responsive for optimal low-cost operations.

Introduction

Buildings consume about 40 percent of total national energy use, are responsible for the same percentage of greenhouse gas emissions, and account for about 70 percent of electricity use (D&R International, 2011). To address energy security and environmental concerns there are urgent needs to reduce energy use in buildings. One of the greatest opportunities to address these needs is to accelerate the development of advanced building energy information and control systems. These systems can improve energy efficiency and automatically respond to dynamic electricity prices by managing electric loads during operations.

This paper provides an overview of research on intelligent energy information and control systems. This includes advanced simulation for model-based control to estimate energy implications of control actions and optimization, and model predictive control to augment these models with dynamics of building system and prediction of future disturbances and inputs. We also summarize recent research and deployment activities related to automated demand response communications and control. As supply and demand side systems become more integrated there is an opportunity for buildings to respond to common grid systems and model-based control will help manage the response. We outline emerging systems, describing three tracks of research, each with different levels of commercialization. We discuss how these technologies need to be integrated into a modular building control operating platform. Since these systems are initially deployed in larger buildings with professional energy managers, we emphasize applications for commercial and institutional buildings. The techniques will be applied to smaller buildings as price points for deployment are reduced over time.

The paper is organized into three remaining sections. The next section discusses basic problems associated in the buildings industry associated with energy efficiency in design and operations, plus challenges in the electric grid systems and the need for demand response. Next we cover research on energy information systems, automated demand response, and model predictive control to evaluate methods to include continuous energy measurements in feedback control systems. We conclude with a summary and discussion of future directions, and introduce the concept of responsive buildings that can provide a platform to respond to multiple needs including grid signals, human factors, and low-energy operations. New capabilities in information technology, web-based data archival platforms, automated communications, and higher resolution of submetering are enabling new capabilities to continuously manage energy use.

Energy Issues in Design, Operations, and Grid Integration

In this section we outline four key factors that influence the design and operations of buildings. These are:

- Low first cost in building design
- Lack of simulation tools and models for performance evaluation of control sequences in design and operation
- Low energy costs, and the lack of dynamic price signals and hourly data to integrate with the electric grid
- Lack of communications and database systems

It is useful to identify why existing practices result in energy-intensive buildings. One technique is to consider the design and operations lifecycle. Two primary design criteria used by owners and architects to evaluate new building designs are first cost and aesthetics. For most buildings, too little attention is given to energy performance goals or criteria. Energy performance requirements in building codes vary, and building systems are often specified to be minimally compliant.

Another reason for the lack of innovation in design is lack of tools and models to assist in co-design and operation of energy and control systems as further described below. Many building systems such as insulation levels, window properties and HVAC sizes are developed using rules of thumb. Even more problematic is the issue that once designed, there is no reference design for how to operate common or complex systems. As we develop low-energy buildings, the need for models to evaluate low-energy control is more urgent than ever. Whole building simulation models are sometimes used in design, but rarely used to assist in operations and they are hard to use for development of control sequences for reasons described below. There is a need to develop tools for co-design of energy systems, control sequences and to support operations.

Not only are first costs a major concern in design, but energy costs themselves are a small percentage of operating costs, thus providing limited motivation for efforts to reduce energy use. The dominant costs for an office building are labor costs for people. Another factor is the lack of time series data limiting understanding of daily energy patterns. The majority of buildings only see monthly energy use, which provides minimal information on how energy is used over time.

Data of electric load shape, temperatures and flow rates are becoming available and the uses of these data for efficiency and demand response are fundamental elements of good operations.

Throughout much of the United States peak electric loads have been growing faster than base loads. Peak loads cause stress on the electric grid causing the need for more capacity, and larger transmission and distribution systems. The majority of the US is summer peaking, and the discussion in this paper emphasizes strategies for summer peak demands. Some regions of the US have winter peaks that are larger than summer peaks, and some regions have large electric peaks in both seasons that require demand response programs that consider both seasons. While increasing peak demands are a challenge for retail service providers and utilities as well as wholesale markets, there is a lack of dynamic price signals for consumers to incentivize them to reduce peak demand. Demand response (DR) is an area of demand side management that has four key benefits. *Participant financial benefits* are bill savings and incentive payments earned by customers who adjust their electricity use in response to time-varying electricity rates or incentive programs. *Market-wide economic benefits* are lowering of wholesale prices as DR averts the need for operating costly peak generation units. Over the long term, sustained DR lowers aggregate system capacity requirements, allowing utilities and other electricity suppliers to build less new capacity. *Reliability benefits* are operational security and adequacy savings achieved because DR lowers the likelihood and consequences of forced outages that impose costs and service interruptions on customers. *Market performance benefits* refer to DR's value in mitigating electricity suppliers' ability to exercise market power by raising power prices above production cost.

Following the electricity crisis of 2001, DR program experience in California showed that customers had limited knowledge of how to operate facilities to reduce electricity costs under dynamic and critical peak pricing (Quantum Consulting Inc and Summit Blue Consulting, 2004 and 2006). While the lack of knowledge about how to develop and implement DR strategies is a barrier to participation in DR programs, another barrier is the lack of automation. Historically DR has been manual requiring operations staff to receive (email, phone call) and act on signals. Quantum and Summit Blue also found that about 15% of the time, the person responsible for responding is not present, which is an obstacle to reliable DR. Below we describe research to automate DR using a standards-based communication system.

The items listed above are related in that current buildings lack integrated information systems for design, operations, energy analysis, and DR. Similarly, buildings are not properly commissioned (Mills, 2009). There are no common standards for database system design, commissioning, or operations data. There is a need to organize information systems to facilitate more efficient design. In most buildings, 10-20% of energy use is wasted as a result of incorrect operational schedules, suboptimal set points, and control problems (Mills, 2009). Although control sequences are important to reduce energy use, designers seldom specify controls sequences at a level that allows controls providers to implement the optimal design intent.

Integrated Energy Information and Controls Systems for Efficiency and Demand Response

In this section we outline current research and the state of commercialization of new technology to address the problems described above.

Energy Information Systems

We define web-based Energy Information Systems (EIS) as performance monitoring software, data acquisition hardware, and communication systems used to store, analyze and display building energy data. Time-series data from on-site meters, temperature and flow sensors, and external data such as weather feeds, are used to perform automated analyses such as baselining, load profiling, benchmarking, and energy anomaly detection. Figure 1 shows that at a minimum EIS provide hourly whole-building electric data that is web-accessible, with analytical and graphical capabilities (Motegi, 2003). EIS may also include submeter, subsystem, or component level data, and corresponding analyses such as system efficiencies or analysis of end uses, yet these are less common of today's typical implementations.

Figure 1. Basic Web-Based Energy Information System

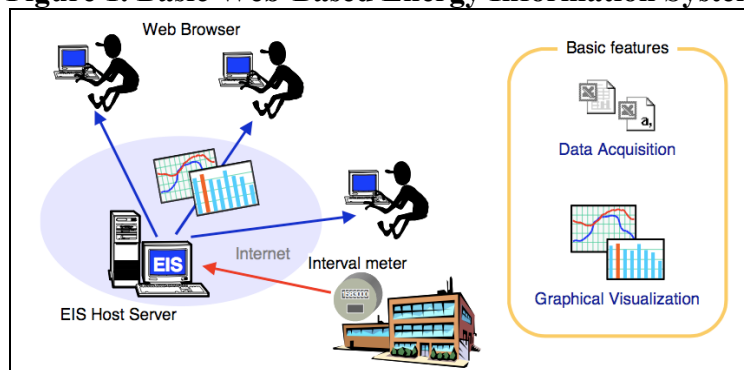

As advanced operational tools that provide real-time visibility into energy performance, EIS can enable a proactive approach to energy management. A growing body of evidence indicates the value of permanent metering and monitoring, particularly in the context of monitoring-based, continuous or retro-commissioning (Mills, 2009). Also pointing to the value of monitoring, researchers have documented the positive behavioral impacts of making energy consumption visible to building occupants (key references are listed in the next paragraph). EIS support trends toward the use of benchmarking and support energy performance disclosure requirements.

While EIS support the *identification* (detection) of energy waste, they depend on user expertise and depth of submetering to resolve the *cause* (diagnosis) of waste and determine the appropriate response. For example, EIS enable an energy manager to observe high nighttime loads, which might be due to over ventilation, lapsed HVAC setbacks, or poorly scheduled lighting. Where appropriate human resources have been allocated to use an EIS and users are empowered to take action to address problems, EIS have been shown to save up to 20% in whole-building energy (Granderson et al., 2011). Case studies have shown 5-25% site or portfolio energy savings, quick payback, high return on investment, and persistent low-energy performance in cases where an organization has implemented a continuous energy monitoring and analysis program, in combination with enabling software tools and accountable staff (Capehart and Middelkoop, 2011; Granderson et al., 2011; Motegi, 2003; Smith et al., 2011). Figures 2 and 3 illustrate examples of savings achieved by EIS users.

Figure 2. EIS at Wal-Mart Led to Identification of a 225 kW Static Load Due to Failed Lighting Control, and \$35,000/yr in Savings

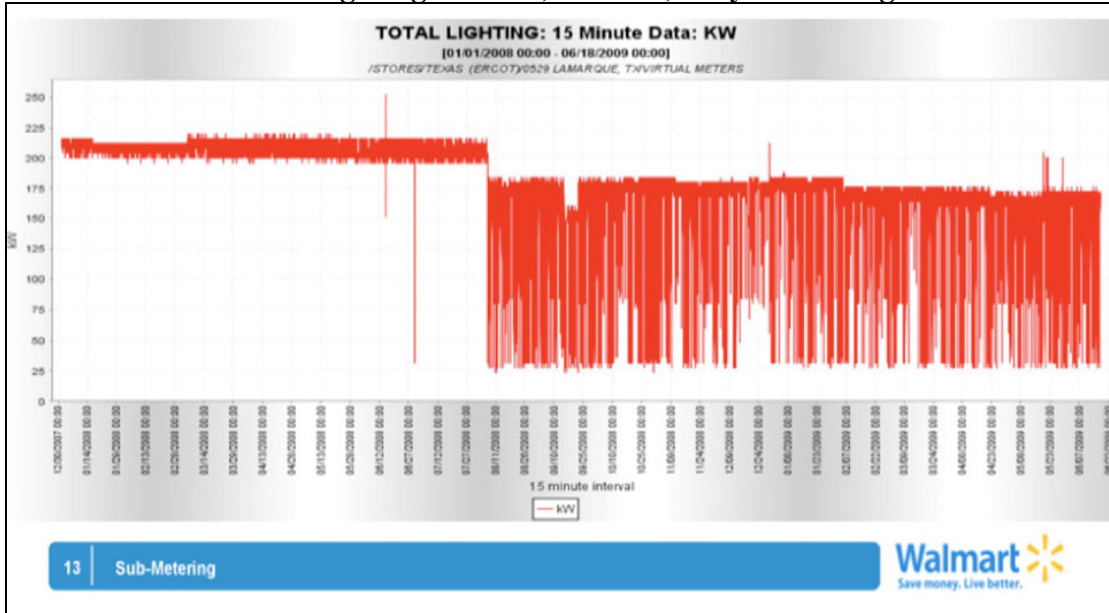
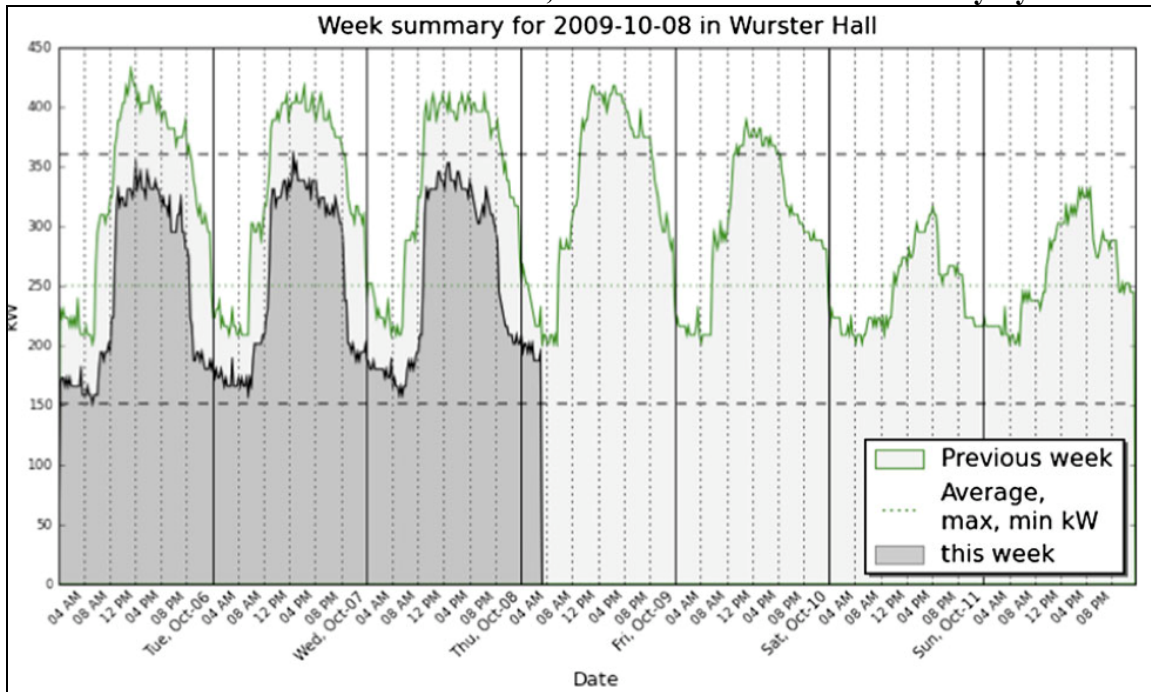

Figure 3. EIS at Wurster Hall, University of California Berkeley Identified Waste from Over-Ventilation and -Illumination; Correction Reduced Electricity by 30%



Although EIS are powerful, they rely on statistical models of historical data to predict future loads, or identify anomalies in energy use. In contrast, tools from physics-based models compute energy consumption of individual components based on thermodynamic, heat transfer and other first principles. For example, a fan's energy consumption may be computed based on performance curves for full load operation coupled to physics-based models that correct for part-

load conditions. These models can be used to automate detection of system or component faults and to identify optimal control strategies to minimize energy use. Recent research has used physics-based models of building energy use at a building in Chicago (Pang et al, 2011). Another value of these models is they can be used to evaluate future retrofits. The buildings industry will benefit from improvements in energy analysis tools as today's more passive energy information systems develop to host physics based analysis and predictive control models as further described below.

Automated Demand Response

Research over the past nine years has shown that commercial buildings can reduce peak electric loads by about ten percent using their HVAC systems and control with a modified control strategy (Kiliccote et al 2010). After years of field work we wrote a guide to common control strategies (Motegi et al, 2007). The majority of the commercial building efforts focused on changing zone set points for variable-air-volume systems. Lighting DR control strategies are also common. Most demand response programs for commercial buildings use manual signals. Levels of DR automation can be defined as follows. Manual DR is labor-intensive, manually turning off or changing set points at each switch or controller. Semi-automated DR involves a pre-programmed DR strategy initiated by a person via centralized controls. Fully automated DR does not involve human intervention and is initiated by an external communications signal. Figure 4 shows the reduction of whole building electric loads for a 130,000 ft² building in Martinez California that used an automated zone temperature reset strategy to reduce peak electric loads during a dynamic pricing event in 2006. The graphic shows a) whole building electric baseline, b) the reduced electric load shape on the DR event day, c) the outside temperature, and d) the “negawatts” (or the predicted baseline minus the actual loads on the DR event day). The HVAC control strategy reduced the electric loads by about 15% on this hot day using a fully automated systems further described below.

We began research on automating DR in 2002 following California's electricity crisis. We sought to develop a low-cost automation system that would represent electricity price signals and connect easily to existing building control systems. The concept was to use the existing Internet for the physical communications layer. From the customer side, the site's electrical load shape is modified by changes in automatically enabling DR control strategies. The technology was named “OpenADR” to distinguish it from proprietary automated DR efforts. OpenADR functions as follows.

Figure 4. Baseline and Reduced Electric Load during Automated Demand Response Event during a Critical Peak Price Event

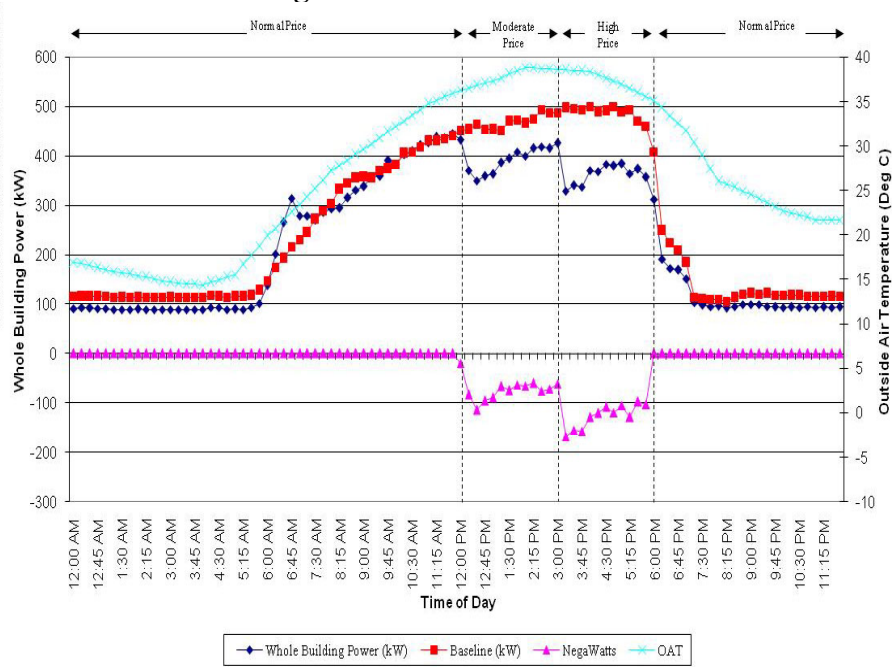

OpenADR uses a client-server communications architecture with an open application-programming interface (API) available for development of building clients embedded in control systems that communicate over the Internet (Figure 5). The DR Automation Server, or DRAS, publishes signals from the utility, or DRAS operator, for the client. Using a “pull” client the web service requests event data from the DRAS every minute. This is a year-round, continuous system. When OpenADR signals a pending DR event, the control system prepares to participate or waits for the event and then executes a pre-programmed DR strategy (Kiliccote et al., 2010). The client sends information to the DRAS to inform the DRAS it has received the most recent signals. OpenADR systems use an XML-based web-service architecture for platform-independent, interoperable systems.

Figure 5. OpenADR Client-Server Architecture

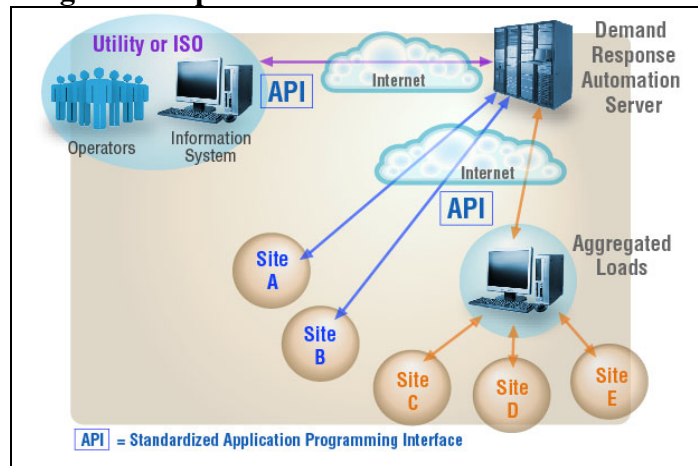

The above description is the most basic use of OpenADR. OpenADR is a general data model that supports a variety of price and DR mode information for both push and pull implementations. Push clients are used for fast response like those in ancillary services. The security used for the DRAS and DRAS clients addresses confidentiality, authentication, and integrity. The data communications between the DRAS and the DRAS clients within facilities is secured using Secure Hyper Transfer Text Protocol (HTTPS) and authenticated using certificates, username, and password. To maintain the confidentiality and integrity of customer information, the HTTPS uses 128-bit encryption so data are secure. Username and password authentication ensures that communications are only allowed between authenticated and known partners. The OpenADR specification, published after six years of field tests was contributed to the National Institute of Standards and Technology efforts on Smart Grid interoperability (Piette et al. 2009). OpenADR version 2.0 will be available in 2012 following the completion of the national standards effort. Kiliccote et al. reviews the deployment of OpenADR in California reviewing the 160 MW of automated DR in stalled (2010). Recent reports by the utilities in California suggest OpenADR will be in stalled to provide over 0.25 GW of load within the next year. This technology is being used in several countries outside the US in Canada, Europe, Asia, and Australia.

Historically building owners and managers have relied on monthly bills as their primary form of feedback on energy use. New tools can organize data into actionable information and automated control. Figure 6 provides a framework for integrating energy efficiency and DR. The definition of energy efficiency means the building provides as much service as possible for each kWh. Demand response often requires temporarily changing the level of service, or shifting the load in time. As the speed of DR increases with better controls and telemetry, the value of the DR is higher for real-time grid controls. OpenADR will allow buildings to listen to grid signals using a standard API.

Figure 6. Linking Energy Efficiency and Demand Response

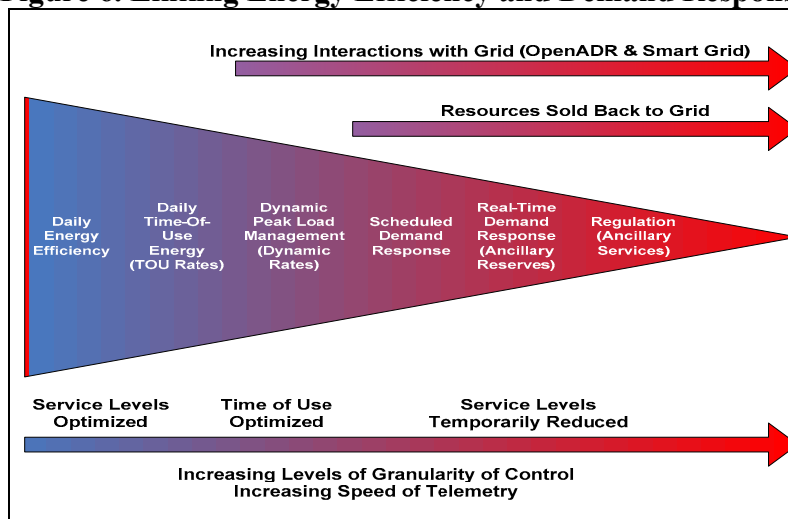

Model-Based Control

The US Department of Energy has supported energy simulation and energy analysis tools for several decades. There has been a disconnect and a performance gap, however, between the

way buildings are designed and how they operate (Turner and Frankel, 2008). One strategy to address this gap is to improve the use of simulation in actual operations. Recent work to develop models that support building controls design and real-time operation is two-fold. Through the Building Controls Virtual Test Bed (Wetter, 2011), users can close control loops across existing simulators, and connect them to control systems for two-way communication (Figure 7). Through the Modelica “Buildings” library (Wetter, 2009), local and supervisory control systems can be modeled including dynamic response of HVAC equipment (Figure 8). These models are modular to allow embedding subsystem models in next-generation energy information systems and model-based control algorithms.

Figure 7. Building Controls Virtual Test Bed with Interfaces to Programs and Control Systems

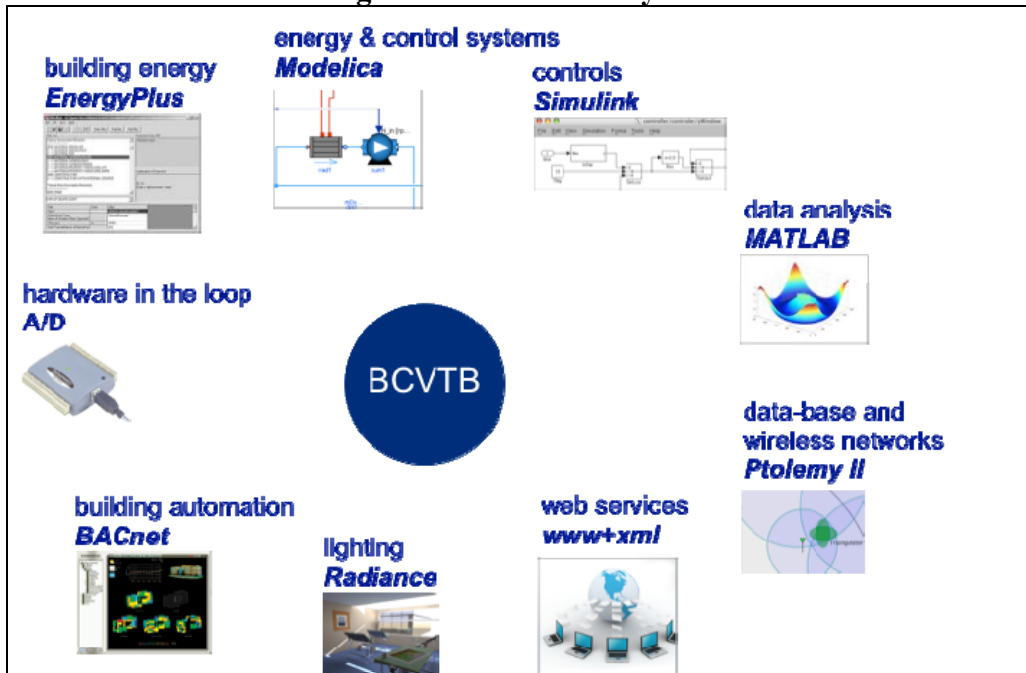
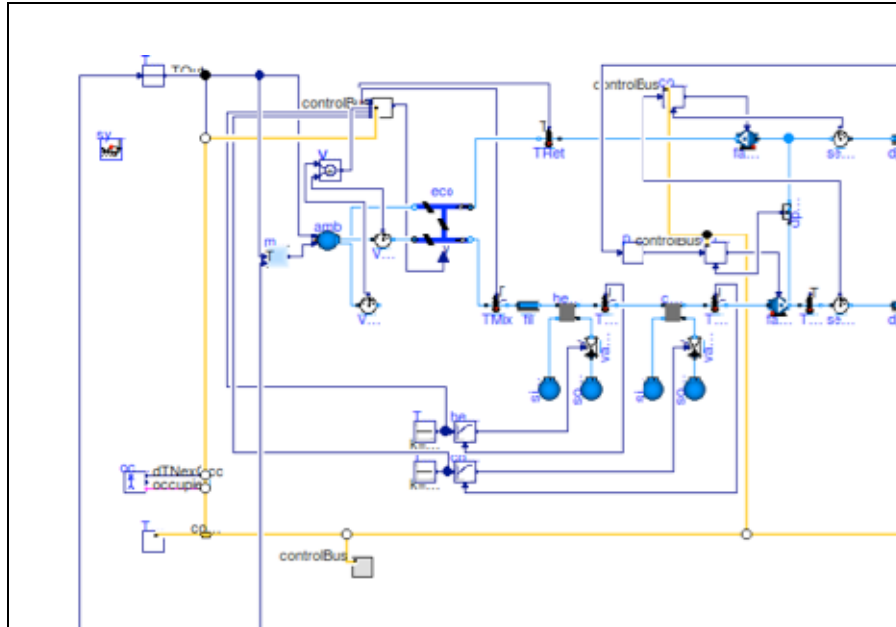

Figure 8. Partial View of a Variable Air Volume Flow System with Duct Static Pressure Reset in Modelica



Closing control loops with the BCVTB allows, for example, the development and performance assessment of closed-loop control algorithms, implemented in MATLAB or Modelica, that integrate light-redirecting façade elements, implemented as a Radiance model, with HVAC loads, computed by EnergyPlus. This coupling among simulators and control systems has been used to develop supervisory control sequences for facades, lighting systems and HVAC systems. It has also been used for real-time performance comparison relative to a building model that represents design-intent (Pang et al., 2011).

While the BCVTB allows reuse of existing building simulation programs, the co-simulation approach with these existing programs has the limitation that data are exchanged at a user-selected time step. This makes it impractical to model closed loop controls with fast transients across, because such stiff systems would require adaptive time steps and implicit integrators. It also makes it impossible to properly model event-driven systems that switch the mode of operation, as this would require state-event handling. Furthermore, existing simulators such as EnergyPlus highly idealize controls by “controlling” steady-state models of HVAC equipment based on required power to meet set-points, as opposed to modeling feedback control loops that measure a state (supply air temperature, duct pressure) and compute an actuation signal (damper position, fan frequency) which affect flow rates based on pressure differences and actuator authority. This semantic difference between control input and output, and the lack of dynamic HVAC equipment models, makes it impractical to develop, test and specify HVAC controls in EnergyPlus.

For this reason, and to support rapid virtual prototyping of new energy systems and control systems, including model-based and model predictive controls, we developed the Modelica “Buildings” library. Modelica is a non-proprietary, equation-based, object-oriented modeling language for the modeling of complex engineered systems that may be defined by differential, algebraic and discrete equations (Mattsson and Elmqvist, 1997). We have been developing the free, open-source Modelica “Buildings” library that contains dynamic simulation

models for air-based HVAC systems, water-based heating systems, controls, heat transfer among rooms and the outside, and multizone airflow, including natural ventilation and contaminant transport. A major difference compared to conventional building simulation is that the “Buildings” library allows implementation of realistic control sequences for supervisory and local loop control as continuous time systems, discrete time systems and state graphs, coupled to dynamic models of HVAC equipment, sensors, actuators, duct networks and buildings. These models can also be used with tools for model order reduction and controls design, as well as model-based or model predictive control. The library has been used to assess the performance of HVAC and façade control systems and for rapid virtual prototyping of innovative systems. It is also used to train professionals in fault-detection and diagnostics through the web-based LearnHVAC program. Future research will include the use of these models in real-time with fault detection and diagnostic algorithms that support energy information systems, and the use of models in real-time as part of model-based and model-predictive control.

Responsive Buildings

Given the rapid pace of innovation occurring in information technology for energy efficiency and demand response it is useful to explore the high level concepts to design an integrated monitoring and control systems that can manage multi-criteria optimization. We propose a simple design concept illustrated in Figure 9. The basic idea is a building needs to be responsive to many factors that influence operations. These include three primary factors. **First**, we consider the people, and what they are doing in the building, or the **internal modes of occupancy**. For example, what is the schedule of occupancy, how many people are present, what are they doing, such as teaching in a school, hosting meetings, using office equipment, or cooking food in a restaurant. We need to develop improved methods for continuous measurement of occupant productivity or proxies such as thermal comfort, visual comfort, or related factors. **Second** we consider the external weather and environment, the **dynamic control and operational modes to adjust operations in response to the external climate and natural environment**. Historically the primary dynamic system has been the HVAC, but with more automated daylighting lighting loads vary with outside conditions. Similarly, with the emergence of photo-chromic and electro-chromic and other dynamic facades we will see more modes of control. These systems can evaluate tradeoffs between solar gains, visible light for daylight, and glare. The **third** key element of control is the response of the building to optimize again the energy supply systems. This may include the dynamic pricing of a sustainable grid, use of local renewables or other on-site energy sources. The building control system can respond to continuous real-time prices or advanced ancillary services signals to change electric loads in response to grid signals. Optimization can consider minimizing operating costs, minimizing carbon footprint, or minimizing energy use. The multi-criteria optimization will be supported by more pervasive submetering in building systems, integrated operating systems, and model-predictive and model-driven controls.

Figure 9. Responsive Buildings Integrate Control to Minimize Energy Use Relative to Occupant Needs, Climate, and Energy Supply Opportunities and Constraints

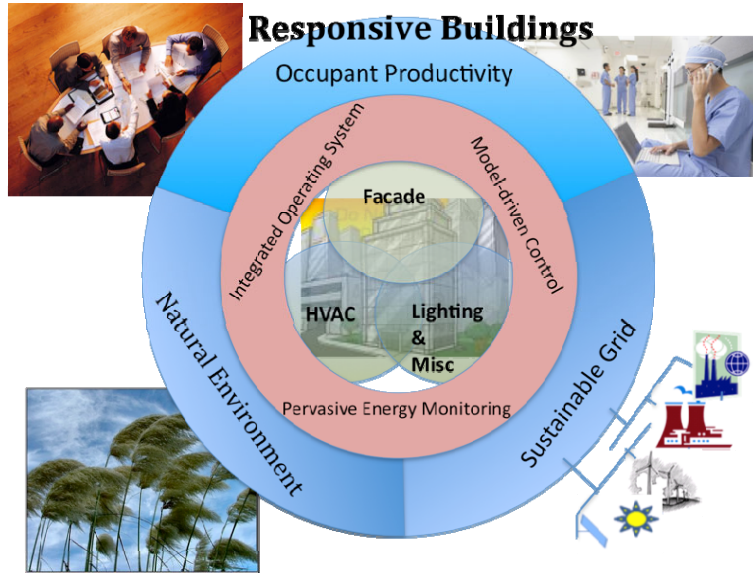

Summary and Future Directions

The ability to collect, organize, evaluate, and present time-series data using emerging information technologies for building owners and facility managers has helped provide a new era of energy efficient building operations. In future design processes, building professionals should be able to specify and improve control sequences, test this specification in simulation for energy use, peak power demand and comfort, implement the controls in actual control systems and commission these systems against the original specification. These would be a radical departure of today's control delivery process in which the designer typically does not or only ambiguously specifies the controls sequences. The controls provider implements some variant of the designer's intent, and results of functional tests are not compared to the original design intent. During *operations*, building control systems and energy information systems will use models that enable consideration of energy use in addition to comfort requirements when computing a control action. Based on the application needs, models with different fidelity and mathematical properties will be used. They will be a combination of physics-based models that use data from design specifications, and data-driven models that use measured data. These models may part of a monitoring system that informs the operator about variations from design intent that may trigger re-commissioning procedures. The models will also be part of model-based or model predictive control algorithms that optimize control sequences for buildings or clusters of buildings to minimize environmental impact subject to comfort constraints, taking into account demand response signals, building-integrated energy storage, and availability of renewable energy for heating, cooling, ventilation and power generation.

Acknowledgements

This work was supported by the Assistant Secretary for Energy Efficiency and Renewable Energy, Office of Building Technology, of the U.S. Department of Energy under

Contract No. DE-AC02-05CH11231 and by the California Energy Commission Public Interest Energy Research program through the Demand Response Research Center at Lawrence Berkeley National Laboratory.

References

- Capehart, Barney, and Timothy Middlekoop, editors. 2011. *Handbook of Web Based Energy Information and Control Systems*. The Fairmont Press, Inc..
- D&R International, Ltd. for the US Department of Energy [DOE]. 2011. *2010 Buildings Energy Data Book*.
- Granderson, Jessica, Mary Ann Piette, and Girish Ghatikar. 2011. "Building energy information systems: User case studies." In *Energy Efficiency* 4(1): 17-30.
- Kiliccote, Sila, Mary Ann Piette, Johanna Mathieu, and Kristin Parrish. 2010. "Findings from 7 Years of Automated Demand Response in Commercial Buildings." In *Proceeding of the ACEEE 2010 Summer Study on Energy Efficiency in Buildings*, Pacific Grove, CA, LBNL Report-3643E.
- Mattsson, Sven Erik Mattson, and Hilding Elmqvist. April 1997. "Modelica – An international effort to design the next generation modeling language." In L. Boullart, M. Loccufier, and Sven Erik Mattsson, editors, *Proceedings of the 7th IFAC Symposium on Computer Aided Control Systems Design*, Gent, Belgium.
- Mills, Evan. 2011. "Building Commissioning, A Golden Opportunity for Reducing Energy Costs and Greenhouse Gas Emissions." In *Energy Efficiency* 4(2): 145-173.
- Mills, Evan and Paul Mathew. 2009. Monitoring-Based Commissioning: Benchmarking Analysis of 24 UC/CSU/IOU Projects. June. LBNL Report No. 1972-E.
- Motegi, Naoya, Mary Ann Piette, Satkatar Kinney, and Karen Herter. 2003. *Web-based Energy Information Systems for Energy Management and Demand Response in Commercial Buildings*. Berkeley, Calif.: Lawrence Berkeley National Laboratory. LBNL Report-52510.
- Motegi, Naoya, Mary Ann Piette, David Watson, Sila Kiliccote, Peng Xu. 2007. Introduction to Commercial Building Control Strategies and Techniques for Demand Response. Report for the California Energy Commission, PIER. LBNL-59975. May.
- Pang, Xiufeng, Prajesh Bhattacharya, Zheng O'Neill, Philip Haves, Michael Wetter and Trevor Bailey. 2011. [Real-time Building Energy Simulation using EnergyPlus and the Building Controls Virtual Test Bed](#). *Proceeding of the 12th IBPSA Conference*, pp. 2890--2896. Sydney, Australia, November.

- Piette, Mary Ann., Girish Ghatikar, Sila Kiliccote, Edward Koch, Dan Hennage, Peter Palensky, and Charles McParland. 2009. *Open Automated Demand Response Communications Specification*. Berkeley, Calif.: Lawrence Berkeley National Laboratory. LBNL Report-1779E.
- Quantum Consulting, Inc. and Summit Blue Consulting, LLC, 2004. “Working Group 2 Demand Response Program Evaluation: Non-participant Market Survey Report”, report to California Working Group 2 Measurement and Evaluation Committee, August 5.
- Quantum Consulting, Inc. and Summit Blue Consulting, LLC, 2006. “Evaluation of 2005 Statewide Large Non-residential Day-ahead and Reliability Demand Response Programs: Final Report”, report to Southern California Edison Company and California Working Group 2 Measurement and Evaluation Committee, April 28.
- Smith, Darrell, Josh Henretig, Jay Pittenger, Rob Bernard, Andri Kofmehl, Abigail Levine, Greg Falco, Kreg Schmidt, Jessica Granderson, Mary Ann Piette. *Energy-smart buildings: Demonstrating how information technology can cut energy use and costs of real estate portfolios*. Accenture, 2011.
- Turner, Cathy, and Mark Frankel. 2008. “Energy Performance of LEED® for New Construction Buildings”, New Buildings Institute, Prepared for US Green Building Council. March.
- Wetter, Michael. 2011. “Co-simulation of Building Energy and Control Systems with the Building Controls Virtual Test Bed.” *Journal of Building Performance Simulation*, 4(3):185-203.
- Wetter, Michael. 2009. “Modelica-based Modeling and Simulation to Support Research and Development in Building Energy and Control Systems.” *Journal of Building Performance Simulation*, 2(2):143-161.
- Xiufeng Pang, Prajesh Bhattacharya, Zheng O'Neill, Philip Haves, Michael Wetter, and Trevor Bailey. November 2011. “Real-time Building Energy Simulation using EnergyPlus and the Building Controls Virtual Test Bed.” *Proceeding of the 12th IBPSA Conference*, pp. 2890--2896. Sydney, Australia.